



**VALVE SOLUTIONS FOR
MINING APPLICATIONS**







Mine Pump Station Expertise

Let the experts at DeZURIK analyze your pump station and provide a custom report that will provide the most cost effective solution over the lifetime of your mine. The analysis takes into account pumping costs (head loss), valve budgetary pricing and relative maintenance costs of various valve types.



Criteria for Optimal Pump Station Performance and Safety

Critical Station Requirements	Pump Reversal, Backspin, Water Hammer Prevention	Pipe Burst & Vacuum Prevention	2nd Option: Water Hammer Prevention	Surge Protection
Product				
Important Product Capabilities	<ul style="list-style-type: none"> • Start up/shut down surge protection • Low head loss • Open & close speed control 	<ul style="list-style-type: none"> • Combination air/vacuum valve • Slow closing - adaptable to pump characteristics 	<ul style="list-style-type: none"> • Fast closure • Low head loss • Non-slam capability 	<ul style="list-style-type: none"> • Opens quickly on pressure surge event • Adjustable closing speed control









Request DeZURIK's Surge Investigation and Valve Suggestions Report by visiting DeZURIK.com or scan:

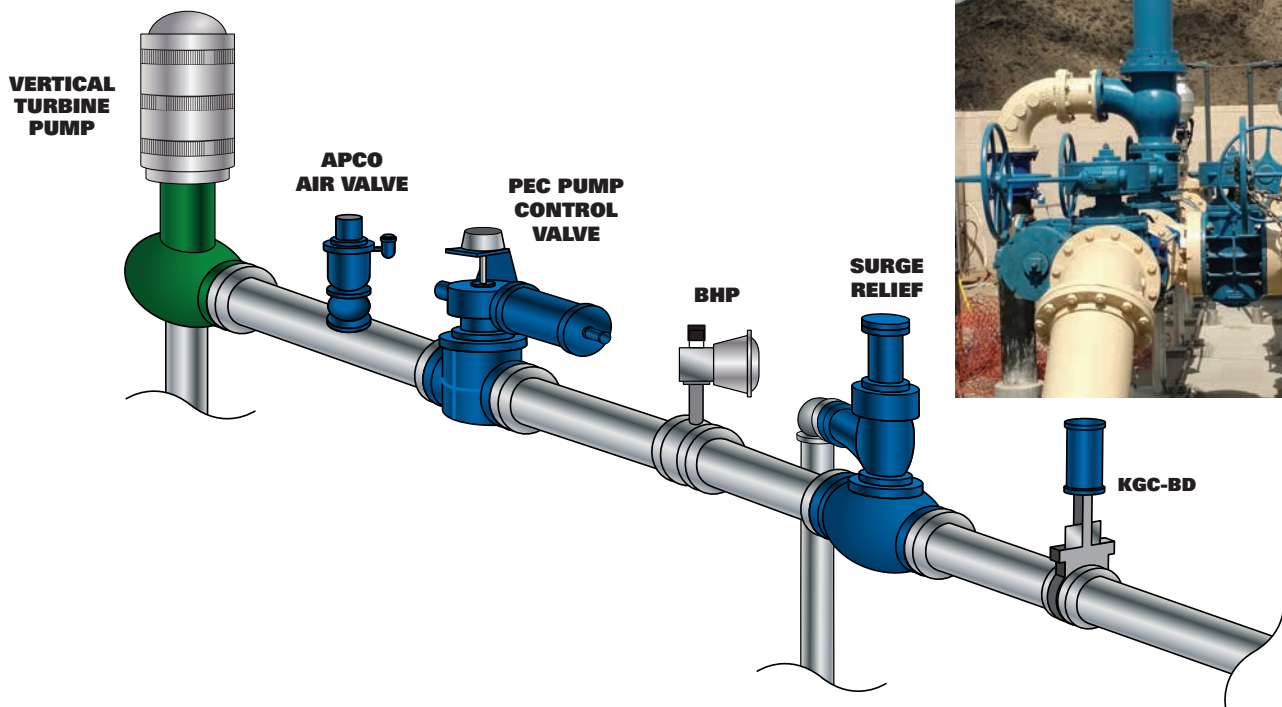

Report includes maximum surge pressure potential, surge period, line velocity, surge wave speed, pipeline constant, and total system head potential during a surge event.

Process & System Water (Pump Station)



Pump Control	Isolation Shutoff Valves		Surge Relief Valves	Air Valves
				
PEC/PEF Pump Check Valves	BHP High Performance Butterfly Valves	KGC-BD Bi-Directional Knife Gate Valves	SRA Surge Relief Angle Valves	ASU Combination Air Valves
<ul style="list-style-type: none"> Serves as both pump check & control valve Adaptable to pump characteristic – specify operating point on pump curve Ductile Iron body, integral nickel seat NBR, EPDM or FKM seal 	<ul style="list-style-type: none"> Lugged 316 Stainless Steel body RTFE seat 2205 or 17-4 pH shaft Handwheel or cylinder operator 	<ul style="list-style-type: none"> 316 Stainless Steel body 316 Stainless Steel gate NBR, EPDM or FKM seal Handwheel or cylinder operator 	<ul style="list-style-type: none"> Ductile Iron body ASME B16.42 ASTM A536 Stainless body seat NBR EPDM FKM seal Self-contained hydraulic seal Stroke counter 	<ul style="list-style-type: none"> Dual chamber 5/16" orifice Valve size based on fill rate or vacuum condition Double-acting throttling device (DAT) for surge protection

Mining Process & Product Overview

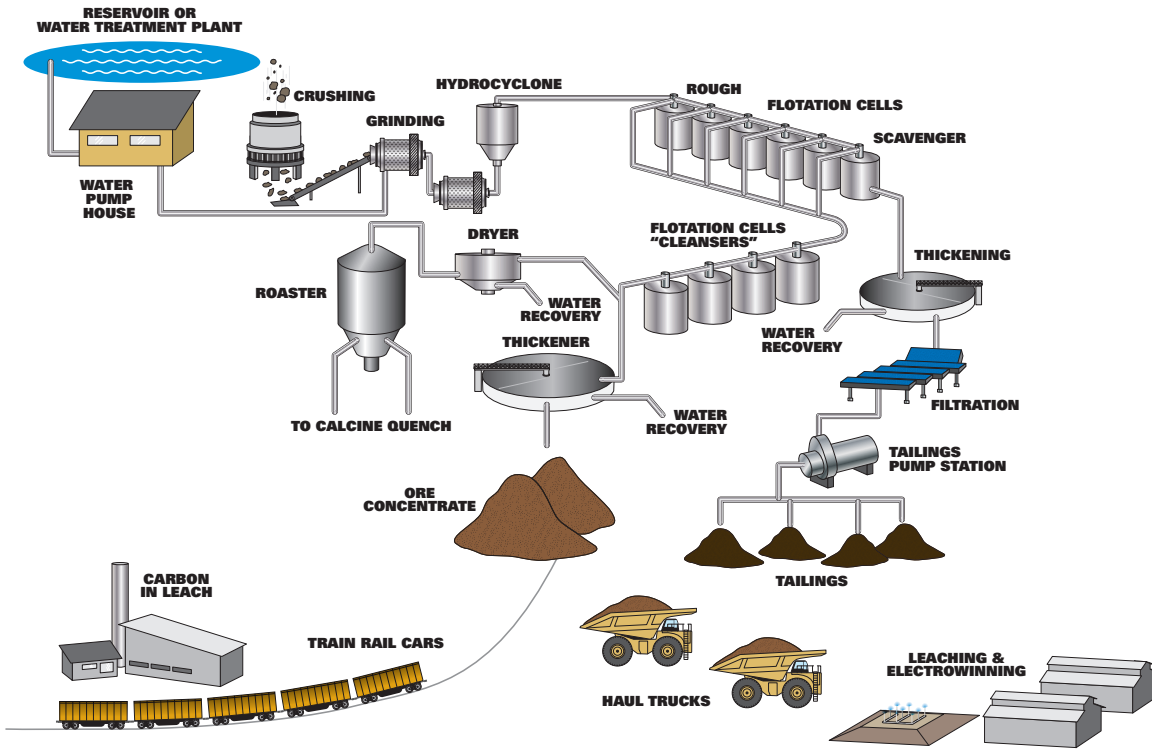

Systems	KNIFE GATE VALVES				SLURRY KNIFE GATE VALVES		URETHANE LINED KNIFE GATE VALVES
	KGN RSB	KGC-ES	KGC-BD	KGC-MD	KSL-SD	KSL-LA	KUL
Grinding							✓
Hydrocyclone					✓	✓	✓
Flotation-Column Cell					✓	✓	✓
Flotation-Supercell					✓	✓	✓
Thickening Filtration					✓	✓	✓
Roasting		✓					
Tailings	✓	✓		✓	✓	✓	✓
Carbon In Leach					✓	✓	✓
Electrowinning Leaching					✓	✓	



Systems	SEVERE SERVICE KNIFE GATE VALVES			COMBINATION AIR VALVES	CHECK VALVES	ECCENTRIC PLUG VALVES	HIGH PERFORMANCE BUTTERFLY VALVES	CONTROL VALVES
	H-290-B	KSV	KSV-DBB	ASU	CRF	PEC	BHP	RCV/VPB
Grinding		✓		✓			✓	✓
Hydrocyclone								
Flotation-Column Cell		✓				✓	✓	
Flotation-Supercell		✓					✓	
Thickening Filtration		✓				✓		
Roasting	✓						✓	
Tailings		✓	✓	✓	✓	✓		
Carbon In Leach		✓				✓	✓	
Electrowinning Leaching				✓			✓	

Seat & Seal Materials

KUL Seat & Seal Materials

Seat Characteristic	Description	Type	Color	Sulfuric Acid	Sodium Cyanide	Wear Abrasion Resistance	Temperature Range
EU	Urethane, General Water Service	Polyether	Black	Not Used	Good	Excellent	-20 to 175° F (-29 to 79° C)
AUCO	Urethane, Oil Service	Polyester	Clear	Not Used	Good	Excellent	0 to 175° F (-18 to 79° C)
EUCW	Urethane, Water Service	Polyether	Clear	Not Used	Good	Excellent	-20 to 210° F (-29 to 99° C)
EUHT	Urethane, High Temp Service	Polyether	Red	Not Used	Good	Good	-20 to 265° F (-29 to 130° C)
BRPA	Urethane, Phosphoric Acid Service	Polybutadiene	Green	Good	Good	Fair	5 to 200° F (-15 to 93° C)

KSV Seat Seal & KSL Sleeve Materials

Seat Seal or Sleeve Characteristic	Description	Valve Type	Sulfuric Acid	Sodium Cyanide	Wear Abrasion Resistance	Temperature Range
NBR	Acrylonitrile-Butadiene	KSV	Not Used	Excellent	Excellent	to 180° F (82° C)
FKM	Fluoro Rubber	KSV	Good	Excellent	Fair	to 400° F (204° C)
CR	Chloroprene	KSV	Not Used	Excellent	Good	to 180° F (82° C)
VGF	Fluorinated Hydro Carbon Fluoro Rubber	KSV	Fair	Excellent	Fair	to 400° F (204° C)
EPDM	Terpolymer of Ethylene, Propylene & A Diene	KSV & KSL	Fair	Excellent	Good	to 250° F (122° C)
HNBR	Hydrogenated Acrylonitrile-Butadiene	KSV & KSL	Excellent	Excellent	Good	to 300° F (150° C)
NR	Natural Rubber	KSL	Not Used	Good	Excellent	to 177° F (80° C)

Dry Powder & Liquor Guide

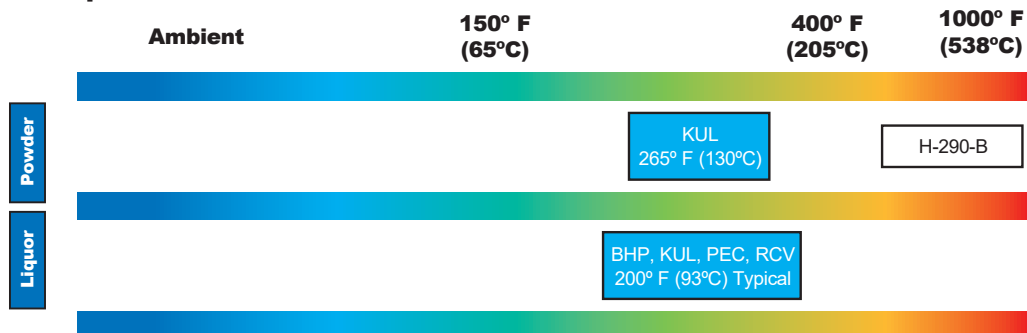

Slurry Guide

Highest Abrasion Resistance/ Pressure										
Broad Application Range										
Economy										
Models	KGN Standard Knife Gate	PEC Eccentric Plug Valve	BHP High Performance Butterfly Valve	KGC Heavy Duty Knife Gate	KUL Urethane Lined Knife Gate	KSL-SD Short Body Slurry Valve	KSL-LA Long Body Slurry Valve	KSV Severe Service Knife Gate	Hilton H-200B Knife Gate	Hilton H-290B Knife Gate
Standard CWP to:	150 psi	450 psi	740 psi	150 psi	250 psi	150 psi	100 psi	740 psi	Over 740 psi	150 psi
Temperature up to:	400°F (204°C)	450°F (232°C)	to 700°F (370°C)	1000°F (540°C)	265°F (130°C)	300°F (150°C)	300°F (150°C)	450°F (232°C)	2000°F (1050°C)	2000°F (1050°C)

Valve Style	Media					
	Raw Water	Dirty Liquids	Light Slurry 0 - 15% Solids	Medium Slurry 15 - 30% solids	Heavy Slurry 30% Solids or More	Extreme Abrasion
KGN	May Be Used	May Be Used	May Be Used			
PEC	Typical Application	Typical Application	Typical Application	Typical Application	May Be Used	May Be Used
BHP	Typical Application	Typical Application	May Be Used	May Be Used		
KGC	Typical Application	Typical Application	Typical Application	May Be Used	May Be Used	
KUL	Typical Application	Typical Application	Maximum Performance	Typical Application	May Be Used	
KSL-SD	May Be Used	May Be Used	Typical Application	Maximum Performance	Maximum Performance	
KSL-LA	May Be Used	May Be Used	Typical Application	Maximum Performance	Maximum Performance	
KSV	May Be Used	May Be Used	Maximum Performance	Maximum Performance	Maximum Performance	Maximum Performance
HILTON H-200B	Typical Application	Typical Application	Typical Application	May Be Used	May Be Used	May Be Used
HILTON H-290B	May Be Used	May Be Used	May Be Used	Typical Application	Typical Application	May Be Used

Rating System:

May Be Used: Thoroughly evaluate the application before selecting this valve. Though this valve may have the lowest initial cost, it would seldom provide the lowest total cost of ownership.

Typical Application: Based on experience, it is very common to install this valve in the stated application.

Maximum Performance: The valve listed as a Maximum Performance has been specifically designed for the stated application in most cases. Although the initial cost will be higher than other valves, the total cost of ownership is typically much lower.

This valve selection chart is designed to provide you with a quick reference on valve style capabilities. The chart considers both cost and performance factors for a specific application when determining whether a valve style is rated Maximum Performance, Typical or May Be Used.

When evaluating a valve for any application, primary considerations are pressure rating, temperature limitations and fluid compatibility. Other considerations include importance of leak-free packing, seat leakage, and frequency of valve operation. Other factors include, but are not limited to fluid velocity, cycle frequency, speed of operation, dimensions and accessibility for installation or maintenance.

For more information, contact DeZURIK, Inc. or your local representative with your specific application requirements.

Grinding

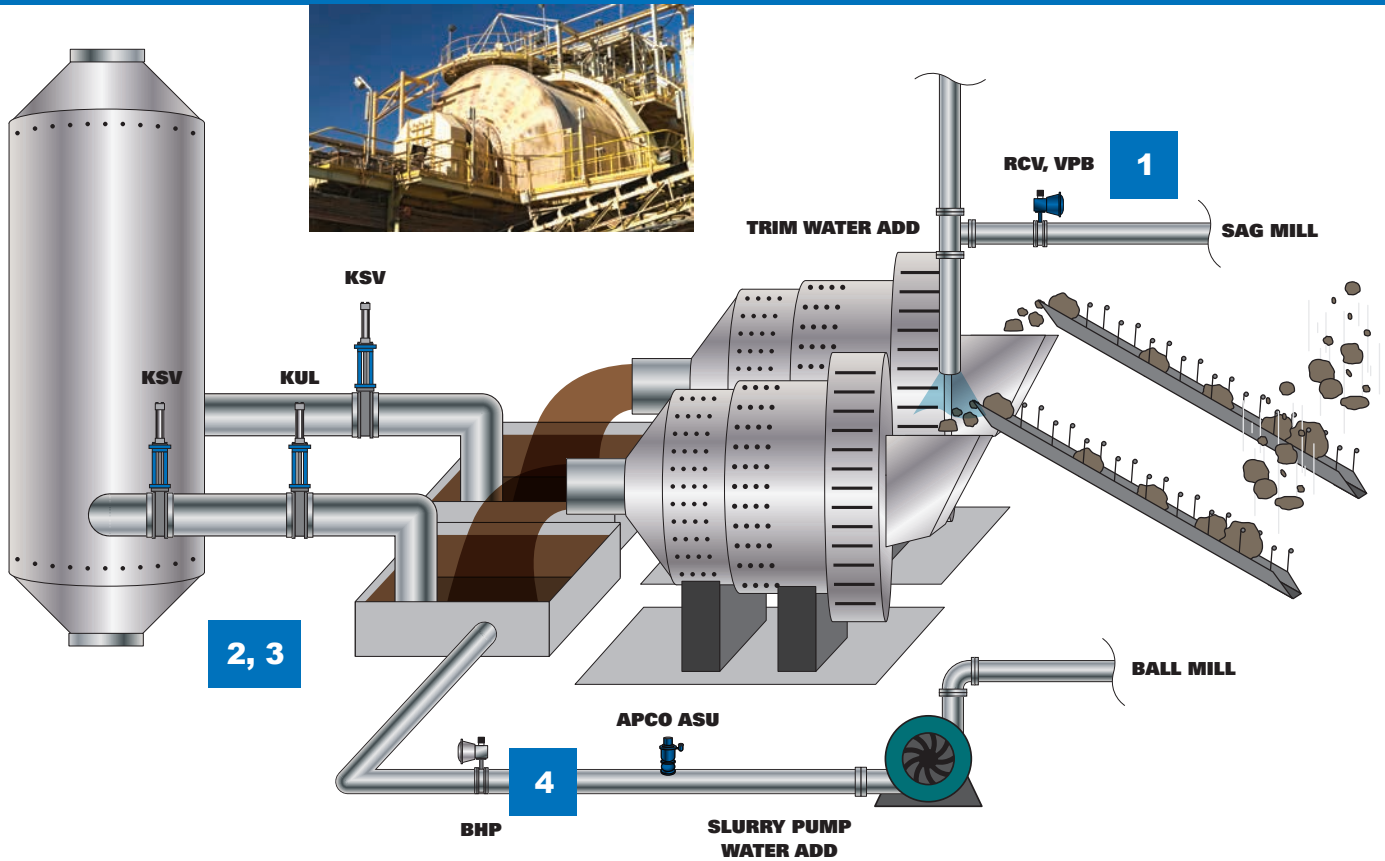

	1. Trim Water Control	2. SAG Mill Isolation	3. Ball Mill Isolation	4. Sump Water Control
	RCV/VPB Rotary or V-Port Control Valves	KSV Severe Service Knife Gate Valves	KUL Urethane Lined Knife Gate Valves	BHP High Performance Butterfly Valves
Aqueous – Chemistry pH	Neutral	May be low pH, if naturally occurring sulfide (sulfuric) in the ore		Neutral
Temperature	Ambient	Ambient		Ambient
Pressure	100 - 150 psi (690 - 1034 kPa)	5 psi (35 kPa)		150 - 300 psi (1034 - 2068 kPa)
Particle Size	N/A (Water)	Small – Medium (Ball Mill)	Medium – Large (SAG Mill)	N/A (Water)
% Solids Content (By Weight)	N/A (Water)	60%		N/A (Water)
Seats / Liner	316 Stainless Steel / PTFE	HNBR	EU	RTFE
Gate Material	N/A	17-4 pH or Stainless Steel with Hardened Nickel Coating	Stainless Steel, Heat Treated	N/A
Body Material	316 Stainless Steel	Carbon Steel	Ductile Iron	Carbon Steel

Hydrocyclone

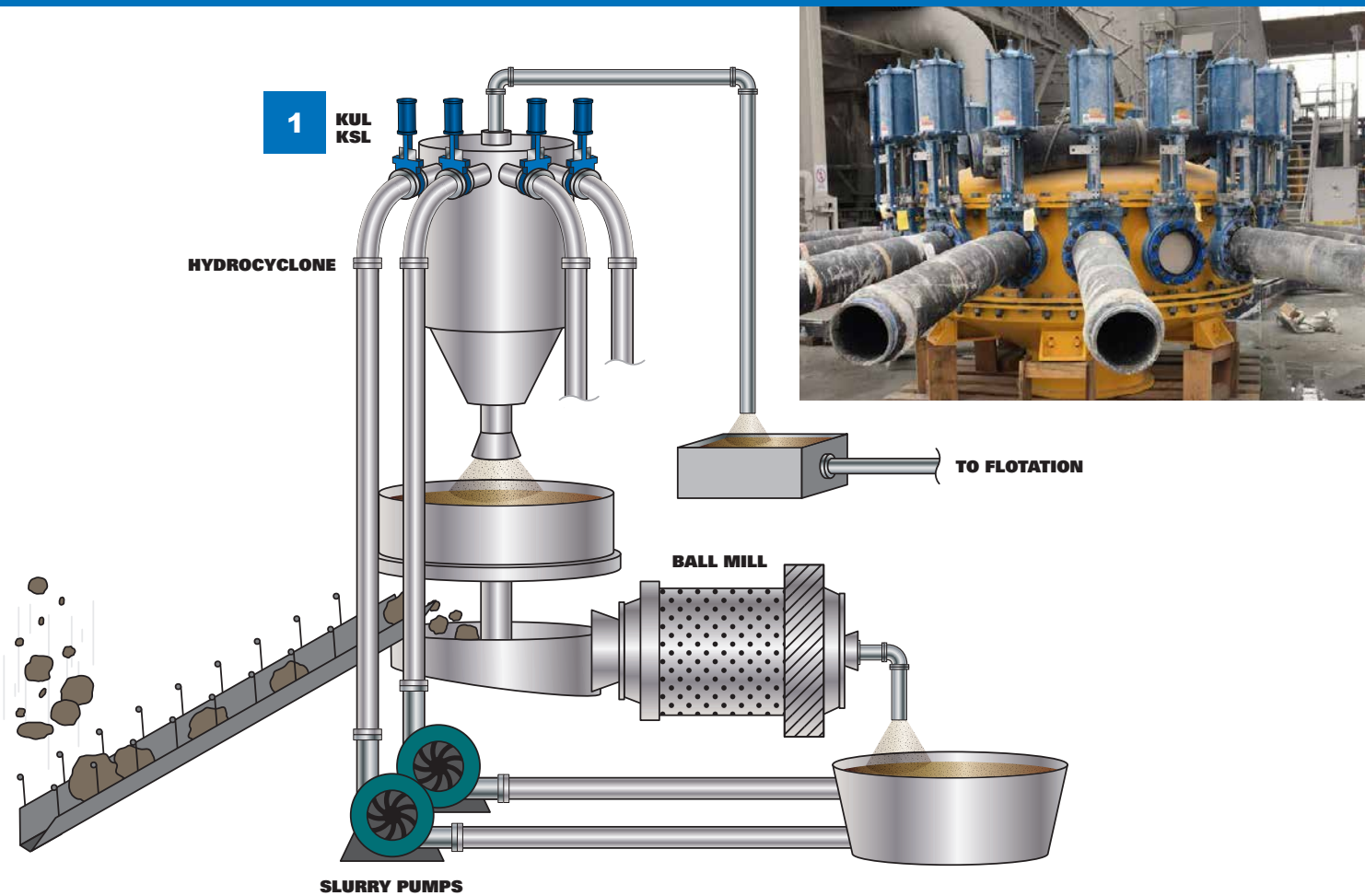

1. Cyclone Diverter Valves

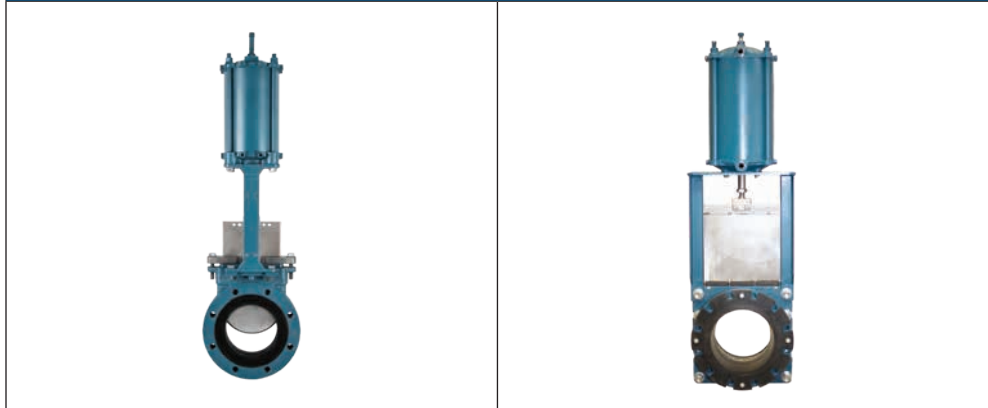

KUL Urethane Lined Knife Gate Valves **KSL Slurry Knife Gate Valves**

Aqueous – Chemistry pH	May be Low pH, if naturally occurring sulfide (sulfuric) in the ore	
Temperature	Ambient	
Pressure	>150 psi (1034 kPa) Pump Discharge	
Particle Size	Small – Medium (First Process After Ball Mill)	
% Solids Content (by Weight)	40%	
Seats / Liner	EU or BRPA	Natural Rubber or HNBR
Gate Material / Body Material	2205, 17-4 pH or Stainless Steel with Hardened Nickel Coating / Ductile Iron	2205, or 17-4 pH or Stainless Steel with Hardened Nickel Coating / Ductile Iron

Flotation - Column Cell

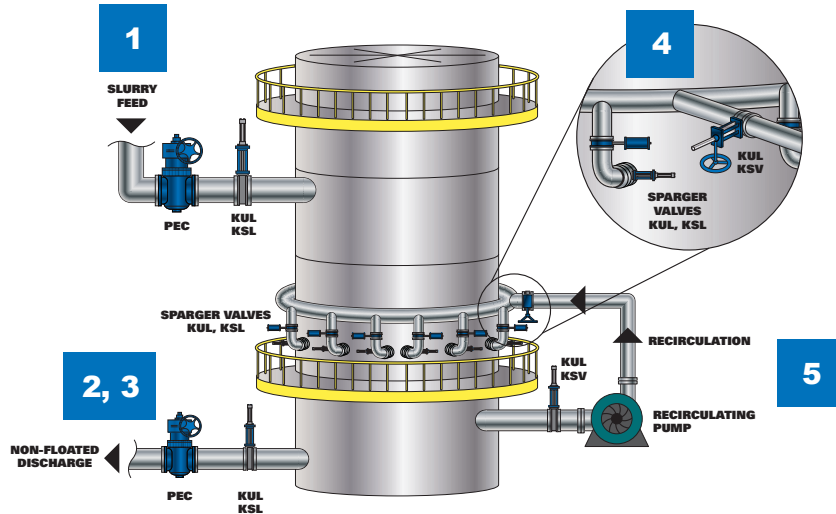



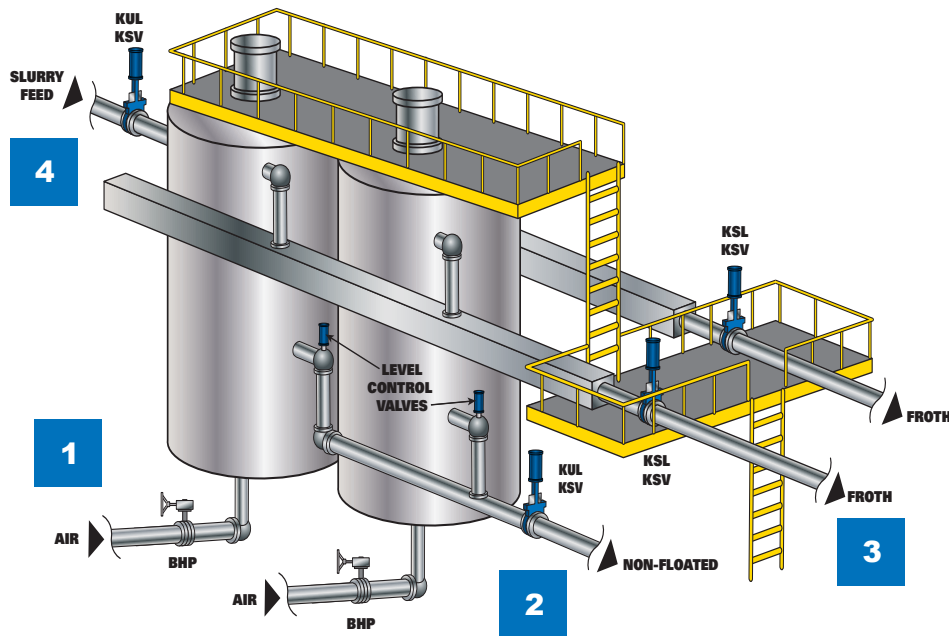

	Air Control	1. Slurry Feed	2. Non-Flated Discharge	3. Non-Flated Tank Isolation	4. Sparger Bypass	5. Slurry Recirculation
	BHP High Performance Butterfly Valves	KSL/KUL Slurry or Urethane Lined Knife Gate Valves	PEC Eccentric Plug Valves	KUL Urethane Lined Knife Gate Valves	KUL Urethane Lined or KSL Slurry Knife Gate Valves	KUL/KSV Urethane Lined or Severe Service Knife Gate Valves

Aqueous – Chemistry pH	Air	Lower pH (trace sulfides & reagents)				
Temperature	Ambient					
Pressure	100 psi (690 kPa)	Column Height in Feet X 2.31 = psi X 6.89 = kPa				> 150 psi (> 1030 kPa)
Particle Size	N/A	Small – Medium				
% Solids Content (by Weight)	N/A	45 - 60%				
Seats / Liner	RTFE	KSV (HNBR) KUL (EU)	NR	EU	KUL (EU) KSL (NR)	KUL (EU) KSV (Carbon) Steel Seat Ring
Gate Material / Body Material	NA / Carbon Steel Lugged	KSV (Carbon Steel or 17-4 pH or Stainless Steel with Hardened Nickel Coating) / Carbon Steel (LCC) KUL (2205 or Stainless Steel with Hardened Nickel Coating) / Ductile Iron	NA / Ductile Iron Rubber Lined	2205 or Stainless Steel with Hardened Nickel Coating / Ductile Iron	KUL (2205 or Stainless Steel with Hardened Nickel Coating) / Ductile Iron KSL (2205) / Ductile Iron	KUL (2205 or Stainless Steel with Hardened Nickel Coating) / Ductile Iron KSV (Carbon Steel or 17-4 pH or Stainless Steel with Hardened Nickel Coating) / Carbon Steel (LCC)

Flotation - Tank / Super Cell



	1. Tank Air Feed	2. Non-Floated Tank Isolation	3. Froth Tank Isolation	4. Slurry Feed
				
	BHP High Performance Butterfly Valves	KUL Urethane Lined Knife Gate Valves	KSL/KSV Slurry or Severe Service Knife Gate Valves	KSV/KUL Severe Service or Urethane Lined Knife Gate Valves

Aqueous – Chemistry pH	Air	Lower PH (trace sulfides & reagents)		
Temperature	Ambient			
Pressure	100 psi (690 kPa)	Column Height in Feet X 2.31 = psi X 6.89 = kPa		Cyclone Pump Discharge
Particle Size	N/A	Small – Medium		
% Solids Content (by Weight)	N/A	45 - 60%		
Seats / Liner	RTFE	EU	KUL (EU)	KUL (EU)
			KSL (NR)	KSV (Carbon Steel Seat Ring)
Gate Material / Body Material	NA / Carbon Steel	2205 or Stainless Steel with Hardened Nickel Coating / Ductile Iron	KUL (2205 or Stainless Steel with Hardened Nickel Coating) / Ductile Iron	KUL (2205 or Stainless Steel with Hardened Nickel Coating) / Ductile Iron
			KSL (2205) / Ductile Iron	KSV (Carbon Steel or 17-4 pH or Stainless Steel with Hardened Nickel Coating) / Carbon Steel (LCC)

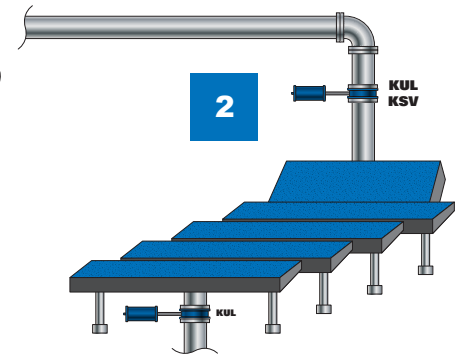
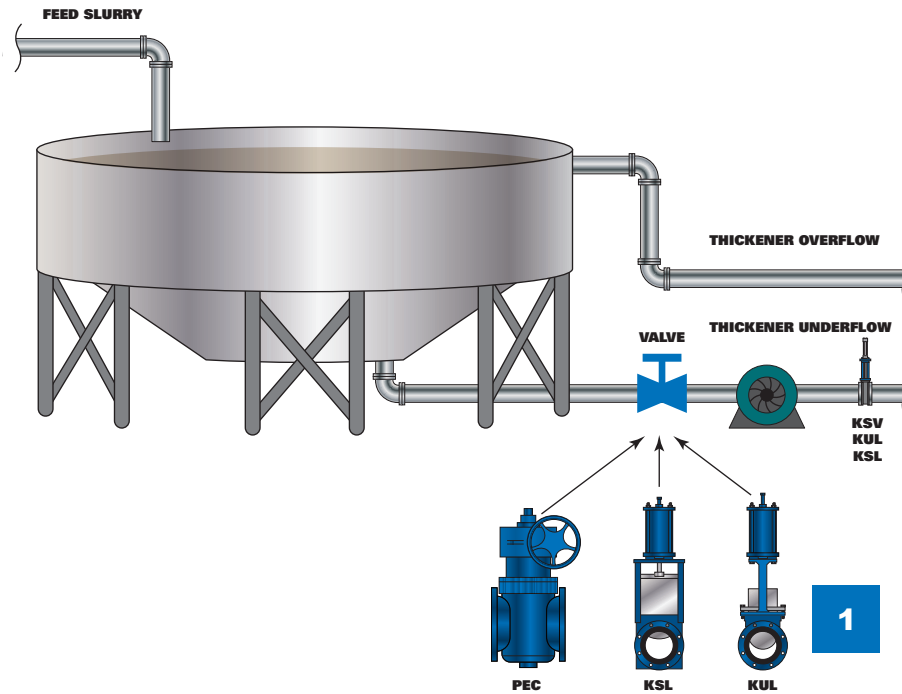

Thickening Filtration



	1. Underflow Thickening Discharge			2. Filtration Bypass	
	PEC Eccentric Plug Valves	KUL Urethane Lined Knife Gate Valves	KSL Slurry Knife Gate Valves	KSV Severe Service Knife Gate Valves	KUL Urethane Lined Knife Gate Valves
Aqueous – Chemistry pH	Higher pH (lime & trace reagents)				
Temperature	Ambient			Ambient	
Pressure	Gravity - (Head) 15 psi (105 kPa) Approx.			<100 psi (<690 kPa)	
Particle Size	Fine			Fine – Coarse	
% Solids Content (by Weight)	45 - 60%			45 - 60%	
Seats / Liner	NR	EU	NR	HNBR	EU
Gate Material / Body Material	NA / Cast Iron or Ductile Iron (Rubber Lined)	2205 or Stainless Steel with Hardened Nickel Coating / Ductile Iron	2205 or Stainless Steel with Hardened Nickel Coating / Ductile Iron	Carbon Steel or 17-4 pH or Stainless Steel with Hardened Nickel Coating / Carbon Steel (LCC)	2205 or Stainless Steel with Hardened Nickel Coating / Ductile Iron

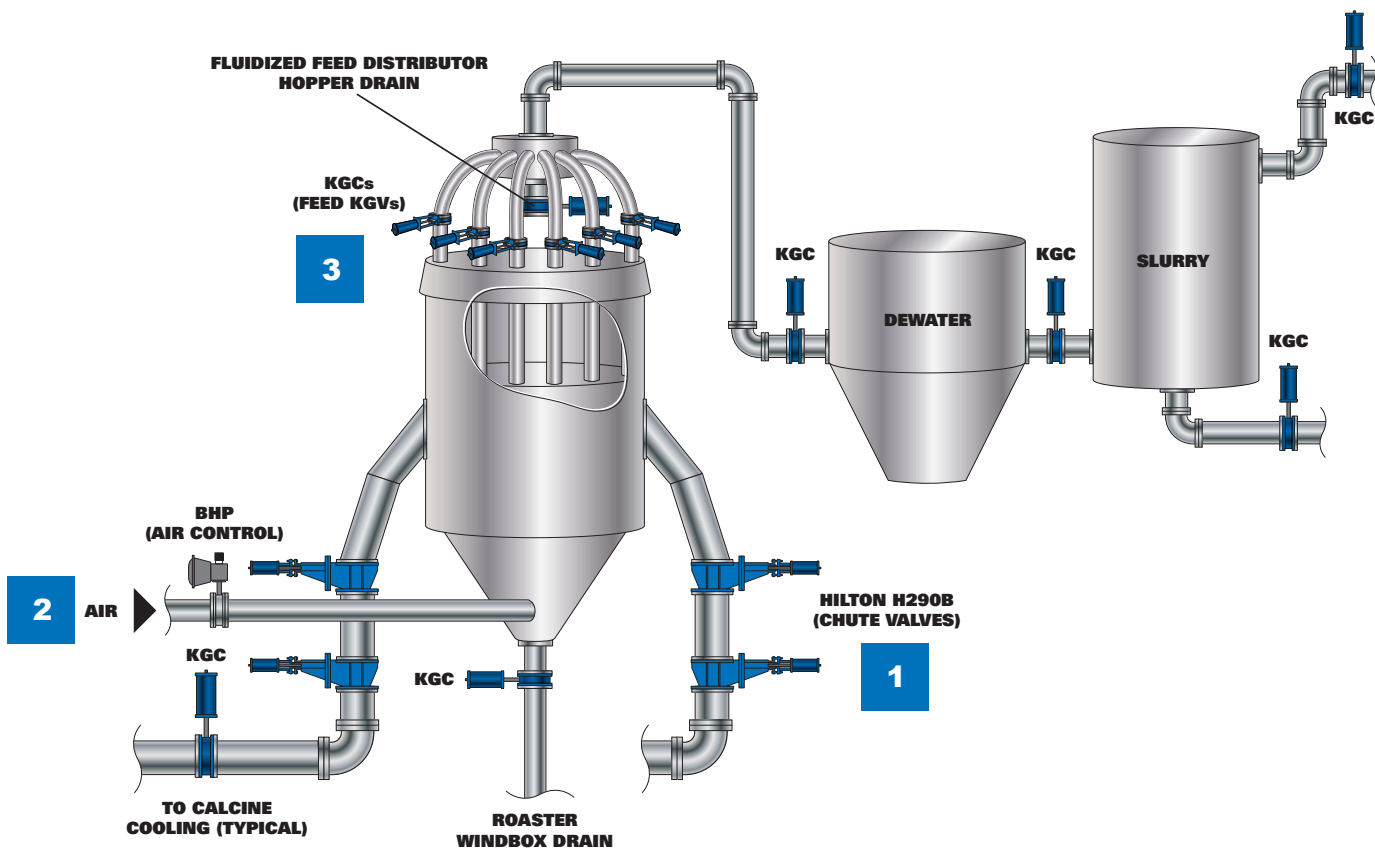





Roasting

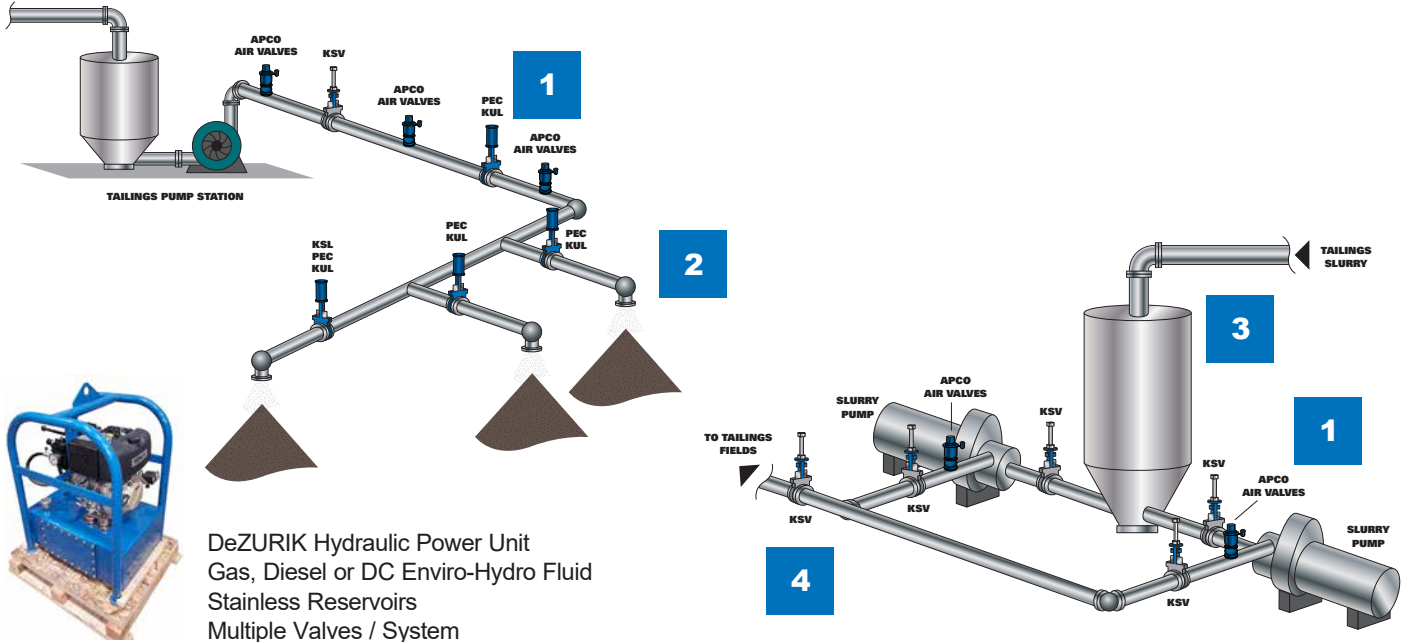

	1. Chute Valves	2. Fluidizing Air to Roaster	3. Feed Distributor & Hopper Bottom Valves
			
	Hilton H-290B Chute Valve	BHP High Performance Butterfly Valves	KGC Stainless Steel Knife Gate Valve
Aqueous – Chemistry pH	Arsenic & Sulfide, Sulfur Compound	Air	Arsenic & Sulfide, Sulfur Compound
Temperature	1500°F (815°C)	110°F (43°C)	Up to 1500°F (815°C)
Pressure	<100 psi (<690 kPa)	5 psi (35 kPa)	5 psi (35 kPa)
Particle Size	Small	NA	Small
% Solids Content (by Weight)	30 - 60%	NA (Air)	30 - 60%
Seats / Liner	310 Stainless Steel	RTFE	310 Stainless Steel
Gate Material / Body Material	310 / 310 Stainless Steel	NA / Carbon Steel	310 Stainless Steel Gate, Body & Bonnet





Tailings

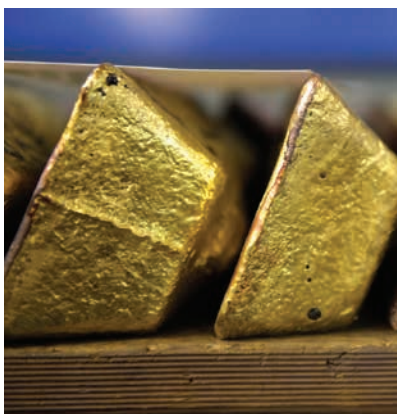
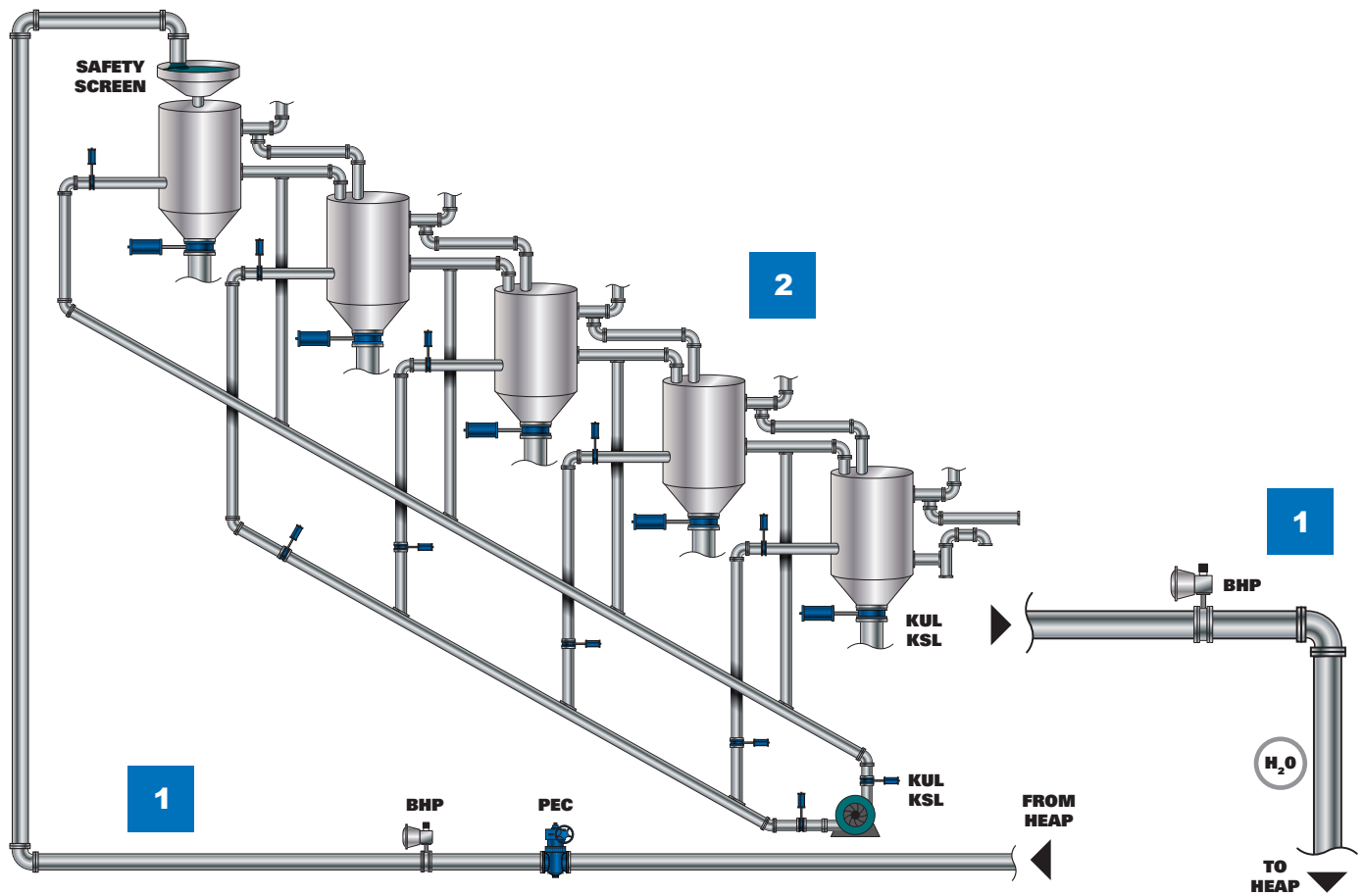

	1. Pipe Burst / Vacuum Protection		2. Tailings Run / Tailings Dam			3. Pump Bypass High Pressure	4. Pump Station
							
	ASU Combination Air Valves	KUL Urethane Lined Knife Gate Valves	KSL Slurry Knife Gate Valves	PEC Eccentric Plug Valves	KSV Severe Service Knife Gate Valves	KUL Urethane Lined Knife Gate Valves	
Aqueous – Chemistry pH	Non Acidic – pH is elevated (lime) aqueous or water content is minimized						
Temperature	Ambient				Ambient		
Pressure	< 250 psi (1720 kPa)				> 300 psi (2068 kPa) for Pump Isolation Discharge <250 psi (1720 kPa) OK for KUL		
Particle Size	Small				Small		
% Solids Content (By Weight)	45% - 70%				30%		
Seats / Liner	NBR	EU	NR	NR	Carbon Steel with Hard welded overlay / HNBR	EU	
Gate Material / Body Material	NA / 316 Stainless Steel Standard Size for Vacuum Protection	2205 (28 Rc Scale) Harder than 316 / Ductile Iron	2205 or Stainless Steel with Hardened Nickel Coating / Ductile Iron	NA / Cast Iron or Ductile Iron (Rubber Lined)	17-4 pH Stainless Steel with Hardened Nickel Coating / Carbon Steel (LCC)	2205 (28 HRC) Harder than 316 Stainless Steel / Ductile Iron	



Carbon in Leach



	1. Water From / To Heap		2. Tank Isolation / Carbon Advance	
				
	BHP High Performance Butterfly Valves	PEC Eccentric Plug Valves	KSL Slurry Knife Gate Valves	KUL Urethane Lined Knife Gate Valves
Aqueous – Chemistry pH	Water from heap may be dirty, particle entrained pond water		Tank isolation and carbon advance slurry is a sodium cyanide aqueous base	
Temperature	45-90°F (32°C)		95-200°F (93°C)	
Pressure	<100 psi (690 kPa)		<100 psi (690 kPa)	
Particle Size	Water (debris)		Small – Medium	
% Solids Content (by Weight)	Depends on source dirt – flotsam possible		23% - 40% Note: If running at 23% – process problem	
Seats / Liner	RTFE (clean)	NR (entrained)	NBR	EU
Gate Material / Body Material	NA / Carbon Steel	NA / Ductile Iron	2205 / Ductile Iron	2205 / Ductile Iron

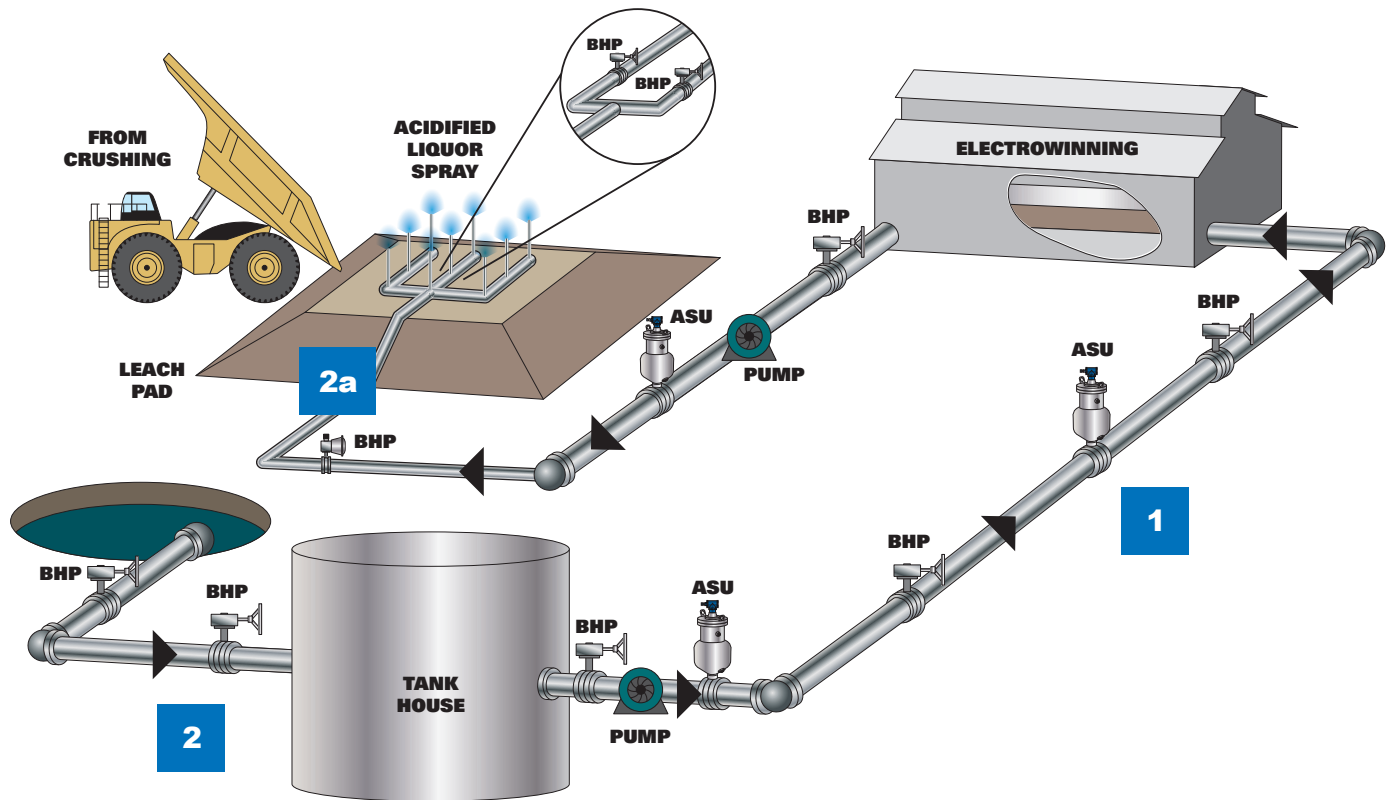

Leaching – Copper Electrowinning



	1. Pipe Burst / Vacuum Protection	2. Solvent Extraction and Electrowinning 2a. Pump Discharge
		
	ASU Combination Air Valves	BHP High Performance Butterfly Valves
Aqueous – Chemistry pH	Pregnant Leach Solution is sulfuric acid based – becomes raffinate liquor – kerosene may be added to remove dirt	
Temperature	Ambient	
Pressure	< 100 psi (690 kPa) > 300 psi pump discharge (2068 kPa)	
Particle Size	Liquor	
% Solids Content (by Weight)	N/A	N/A
Seats / Liner	HNBR	RTFE (BHP)
Gate Material / Body Material	NA / 316 Stainless Steel Standard Size for Vacuum Protection	NA / 316 Stainless Steel

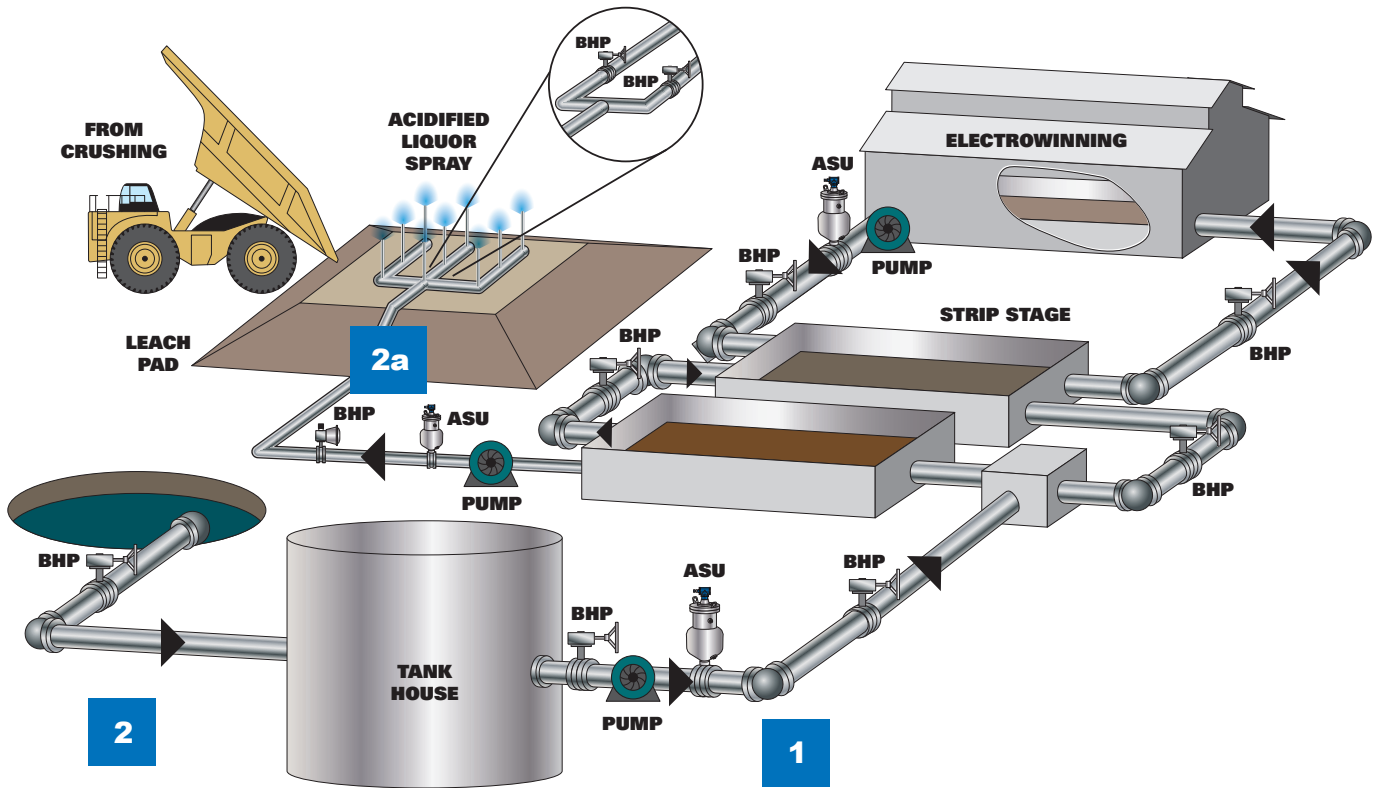





Leaching – Gold Electrowinning

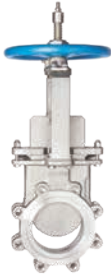

	1. Pipe Burst / Vacuum Protection	2. Solvent Extraction and Electrowinning 2a. Pump Discharge
		
	ASU Combination Air Valves	BHP High Performance Butterfly Valves
Aqueous – Chemistry pH	Pregnant Leach Solution is sodium cyanide based	
Temperature	Ambient	
Pressure	< 100 psi (690 kPa) > 300 psi Pump Discharge (2068 kPa)	
Particle Size	Liquor	
% Solids Content (by Weight)	N/A	N/A
Seats / Liner	HNBR	RTFE (BHP)
Gate Material / Body Material	NA / 316 Stainless Steel Standard Size for Vacuum Protection	NA / 316 Stainless Steel or Carbon Steel









Product Selection Guide General Media and Mining Process



	KNIFE GATE VALVES				SLURRY KNIFE GATE VALVES		URETHANE LINED KNIFE GATE VALVES
	400°F (204°C)	1000°F (540°C)	400°F (204°C)	500°F (260°C)	300 °F (150°C)	300 °F (150°C)	265°F (130°C)
Temperatures up to							
Pressures up to	150 psi	150 psi	150 psi	150 psi	150 psi	100 psi	250 psi
Media / Process							
	KGN RSB	KGC-ES	KGC-BD	KGC-MD	KSL-SD	KSL-LA	KUL
Slurries – Light Thickening	May Be Used	Typical	May Be Used	Typical	Typical	Typical	Typical
Slurries – Medium Grinding / Tailings	Limited	May Be Used	Limited	May Be Used	Typical	Typical	Typical
Slurries – Heavy SAG Grinding / Tailings	Limited	Limited	Limited	Limited	Limited	Typical	May Be Used
Corrosive Media / Sulfuric Acid / CIL Copper	Typical	Typical	Typical	Typical	May Be Used	May Be Used	Typical
Corrosive Media / Sodium Cyanide / CIL Gold	Typical	Typical	Typical	Typical	May Be Used	May Be Used	Typical
Steam Autoclave / Autoclave Vent	Limited	Limited	Limited	Limited	Limited	Limited	Limited
Supply & Wash Water	Typical	Typical	Typical	Typical	May Be Used	May Be Used	Typical
Water Treatment Disposal	Typical	Typical	Typical	Typical	May Be Used	May Be Used	Typical
Dry Materials Roasting	Typical	Typical	Limited	Typical	May Be Used	May Be Used	Typical
Dry Material Column Handling Roasting	Limited	Limited	Limited	Limited	Limited	Limited	Limited
Gases	May Be Used	May Be Used	May Be Used	May Be Used	May Be Used	May Be Used	May Be Used

Product Selection Guide General Media and Mining Process



	HILTON CHUTE VALVES	SEVERE SERVICE KNIFE GATE VALVES		COMBINATION AIR VALVES	RUBBER FLAPPER CHECK VALVES	ECCENTRIC PLUG VALVES	HIGH PERFORMANCE BUTTERFLY VALVES	ROTARY OR V-PORT CONTROL VALVES
Temperatures up to	2000°F (1050°C)	450°F (232°C)	450°F (232°C)	180°F (82°C)	425°F (218°C)	450°F (232°C)	700°F (370°C)	1000°F (540°C)
Pressures up to	150 psi	740 psi	740 psi	150 psi	250 psi	450 psi	740 psi	740 psi
Media / Process								
	H-290-B	KSV	KSV-DB	ASU	CRF	PEC	BHP	RCV / VPB
Slurries – Light Thickening	Typical	Typical	Typical	Typical	Typical	Typical	May Be Used	Typical
Slurries – Medium Grinding / Tailings	Typical	Typical	Typical	Typical	Typical	Typical	Limited	Typical
Slurries – Heavy SAG Grinding / Tailings	May Be Used	Typical	Typical	May Be Used	May Be Used	May Be Used	Limited	May Be Used
Corrosive Media / Sulfuric Acid / CIL Copper	May Be Used	Typical	Typical	Typical	Typical	Typical	Typical	May Be Used
Corrosive Media / Sodium Cyanide / CIL Gold	May Be Used	Typical	Typical	Typical	Typical	Typical	Typical	May Be Used
Steam Autoclave / Autoclave Vent	Limited	Limited	Limited	Limited	Limited	Limited	Typical	Typical
Supply & Wash Water	May Be Used	Typical	Typical	May Be Used	Typical	Typical	Typical	Typical
Water Treatment Disposal	May Be Used	Typical	Typical	Typical	Typical	Typical	Typical	Typical
Dry Materials Roasting	Typical	Limited	Limited	Limited	Limited	May Be Used	Limited	May Be Used
Dry Material Column Handling Roasting	Typical	Limited	Limited	Limited	Limited	Limited	Limited	Limited
Gases	May Be Used	May Be Used	May Be Used	May Be Used	May Be Used	Typical	Typical	Typical

Facilities



DeZURIK Corporate Headquarters and Manufacturing Facility, Sartell, MN, USA
Established in 1928, 420,000 sq. ft.



DeZURIK Cambridge, Ontario, Canada
Established in 1961, 50,000 sq. ft.



Rapid Fulfillment Center, Houston, TX, USA
Established in 2018, 43,000 sq. ft.



DeZURIK, Redmond, WA, USA
Established in 1952, 25,000 sq. ft.

Sales and Service

For information about our worldwide locations, approvals, certifications and local representative:

Web Site: DeZURIK.com E-Mail: info@DeZURIK.com



250 Riverside Ave. N. Sartell, Minnesota 56377 • Phone: 320-259-2000 • Fax: 320-259-2227

DeZURIK, Inc. reserves the right to incorporate our latest design and material changes without notice or obligation. Design features, materials of construction and dimensional data, as described in this bulletin, are provided for your information only and should not be relied upon unless confirmed in writing by DeZURIK, Inc. Certified drawings are available upon request.